

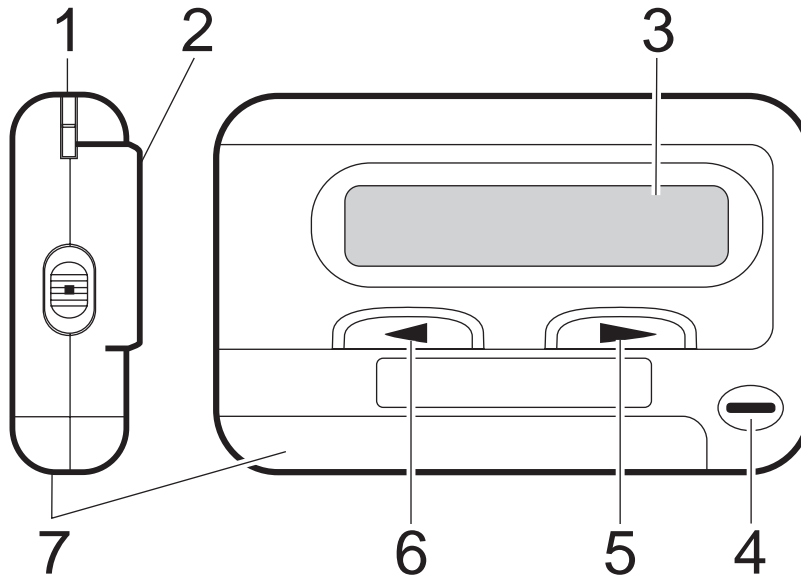



Controls



1. **Strap Attachment**
 2. **Side Key** () - power on/off, selects pager alert modes, and selects built-in menus for setup.
 - Bottom position - pager off
 - Middle position - pager on and set to vibrate
 - Top position - pager on and set to audio alert mode. (See page 4.)
 3. **Display** (refer to next page)
 4. **Speaker**
 5. **Forward scroll** () **Key**
 6. **Backscroll** () **Key**
- Note:** *To stop the page alert, press & release any key.
To light the display, press and hold any key for two seconds.*
7. **Battery Cover**

Display Indicators

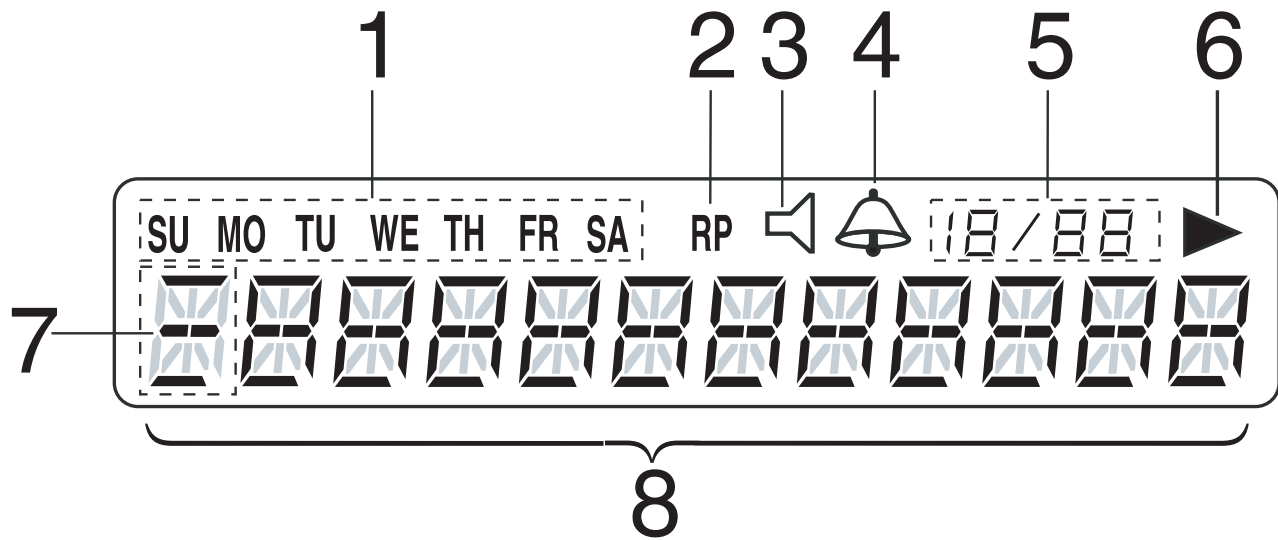

1. **Day Indicator**

2. **RP (duplicate message) - Repeat Page**

3. **Audio Alert Indicator**

4. **Alarm Mode Indicator**

5. **Month/Day/Message Number Indicator**

6. **Message Continued**

7. **Range Indicator**

and first character
of the 12-Character Display

Strong



Weak

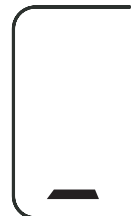

8. **12-Character Display**

Introduction

Congratulations on your purchase of a FLX 9050! This compact, state-of-the-art pager has many features:

Five Programmable Message Tags that store messages with eight characters each

Quick View for easy message viewing

Day/Date/Time Stamp for each message

Time/Day/Date Alarms that are either audio or silent.

To ensure that you understand all the features and capabilities of your FLX 9050, please read this Operating Guide carefully before using it.

Note: Throughout the Owners Guide, the action (i.e., press a key) is first, followed by a display of the results.

press , you will see: *RESULTS*

Also, we have included a visual guide foldout on the inside of the front cover.

Pager Setup

Alert Tone

MO 12/1
----- 10:45A

1.

press: display:



USER MENU



ALERT SET



ALERT 1

Note: If the pager has any messages, you will see:

MO 12/1
=0000 10:45A



USER MENU



DELETE ALL



ALERT SET



ALERT 1

2. Scroll through the Alert Tone options:

Alert 1 through 8

Non-stop Vibrate

Silent Alarm

ALERT 1
ALERT 2
ALERT 3
ALERT 4
ALERT 5
ALERT 6
ALERT 7
ALERT 8
NON-STOP VIB
SILENT ALERT

Note: Press to move forward to the next screen or move backward to return to a previous display.

3. Stop on the Alert Tone you want:

SILENT ALERT

4. To enter your selection into memory, press .

AUTO RESET

Next, choose between the two Alert Tone Duration modes:
Auto Reset - Alert tone stops after eight seconds,
or press any key.

Non-Stop - Alert tone continues until you press any key.

1. To select the Alert Tone duration that you want, press .

NON-STOP

2. Press  to enter your selection into memory.

The Standby display returns showing the Audio Alert indicator.

MO   12/1
10:45A

To test the alert tone you selected, move  between “Vibrate” and “Audio Alert.”

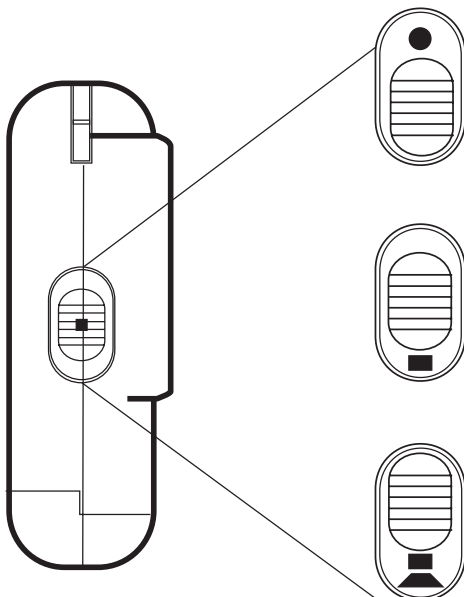

Power Off

Power On/Vibrate Alert

Power On/Audio Alert

Auto Hyphen

Your FLX 9050 can automatically hyphenate numbers in messages. The person calling can use a telephone keypad to enter telephone numbers as a message:

Less than 7 digits, no hyphenation.

555444

Seven digits:

555-4444

More than 7, but less than 10 digits:

555-4444-12

Ten through 21 digits:

000-555-4444

Note: *More than 22 digits will not be hyphenated.*

Start Auto Hyphen - Without messages in memory:

1. To reach the Auto Hyphen Menu,

MO
- - - - 12/1
10:45A

press:

display:



USER MENU



ALERT SET



AUTO HYPHEN



HYPHEN OFF

To turn on,

press:

display:

2.

HYPHEN ON

To turn off,

press:

display:

2.

HYPHEN OFF

3. Press to enter your selection into memory.

Start Auto Hyphen - With messages in memory:

1. To reach the Auto Hyphen Menu,



press: display:



USER MENU



DELETE ALL



ALERT SET



AUTO HYPHEN



HYPHEN OFF

To turn on,

press: display:

2.

HYPHEN ON

To turn off,

press: display:

2.

HYPHEN OFF

Then . . .

3. Press to enter your selection into memory.



Quick View

Quick View On/Off - Without messages in memory:

With the pager on,

1. To reach the Quick View menu,



press: display:



USER MENU



ALERT SET



AUTO HYPHEN



USER MESSAGE



MESSAGE FILE



QUICK VIEW



QUICK OFF

To turn on,

press: display:

2.

QUICK ON

To turn off,

press: display:

2.

QUICK OFF

Then . . .

3. To enter selection,

press:

display:

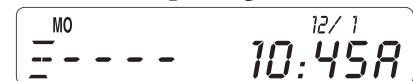

Turn Quick View On/Off - With messages in memory:



1. To reach the Quick View menu,

press: **display:**



USER MENU



DELETE ALL



ALERT SET



AUTO HYPHEN



USER MESSAGE



MESSAGE FILE



QUICK VIEW



QUICK OFF

To turn on,

press: **display:**

2. 

QUICK ON

To turn off,

press: **display:**

2. 

QUICK OFF

Then . . .

press: **display:**

3. To enter your selection







Setting Time & Date Functions



Setting the Time



1. To reach the Time Set menu,

press: display:



 

 

The display shows current time stored in memory, with the hours digit and “P” indicator flashing.

The 12 or 24 in the upper right corner indicates either a 12-hour format, with **A** (a.m.) and **P** (p.m.) indicators, or a 24-hour format.

2. Press  or  to change the hour. The **A** or **P** display alternates after each 12-hour cycle.
3. To enter your selection and move to the next part of the display, press .
■ Repeat the process to set the minutes and 12 or 24-hour format.

4. Press  to enter your selection into memory. The display returns to Standby showing the new time.



Setting the Date

1. To reach the Date/Day Set menu,

press:

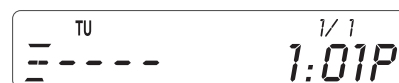

display:

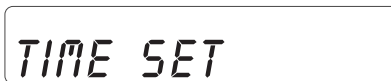

The current month and date stored in the memory appear with the day icon flashing.

2. To select the day of the week, press or .



3. To enter your selection and move to the next part of the display, press .

■ Repeat the process to set the month and date.

4. Press to enter the Day/Date Settings into memory.

The display returns to Standby showing the new date and day.



Activating the Time Stamp

1. To reach the Time Stamp menu,



press:

display:



USER MENU



TIME MENU



TIME SET



DAY/DATE SET



TIME STAMP



STAMP OFF



STAMP ON

2. To turn on Time Stamp,

3. Press  to enter your selection into memory.

The display returns to Standby.



Activating and Setting Alarms

The user-programmable alarms are:

- Separate alarms for time, day, & date
- Time Alarm for the same time each day
- Day Alarm for a specific day and time
- Date Alarm for a specific date and time
- Set audio or vibrate alarm for one event each
- Bell icon appears in the display when an alarm is set
- Alarms are active when the pager is on or off.

Note: Each alarm must be activated before it can be set.

Activating the Time Alarm

1. To reach the Time Alarm menu,



press: display:



USER MENU



TIME MENU



ALARM MENU



TIME ALARM



TIME ALM OFF

2. To turn Time Alarm on, press . A bell icon appears in the display.



TIME ALM

Setting the Time Alarm

From the “TIME ALM ON” display:



TIME ALM

1. Press .



ALM- 5:00A

2. To select the hour, press or .

3. To enter your selection and move to the minutes display, press . Repeat to set the minutes and to choose alarm type (audio or vibrate).

4. Press to enter into memory. When an alarm is set, a bell icon appears in the display.



MO 1:01P

Activating the Day Alarm

1. To reach the Day Alarm menu,

press:

display:



USER MENU



TIME MENU



ALARM MENU



TIME ALARM



DAY ALARM



DAY ALM OFF

2. To turn Day Alarm on, press

DAY ALM ON

3. To enter your selection and move to the next display, press .

ALM- 5:00A

Setting the Day Alarm

From the “DAY ALM ON” display:

1. Press .

DAY ALM ON

ALM- 5:00A

2. To select the day, press or .

3. To enter your selection and move to the next part of the display, press .













Repeat the process to set the hour, minutes, and alarm type (audio or vibrate).

4. Press to enter the selection into memory.

The display returns to Standby with a bell icon.

Activating the Date Alarm

1. To reach the Date Alarm menu,

press:	display:
	
	
	
	
	
	
	

2. Press  to turn Date Alarm on.



3. To enter your selection and move to the next display, press .



Setting the Date Alarm





From the “DATE ALM ON” display:

A rectangular display showing the text "DATE ALM ON" in a digital font. A small bell icon is positioned above the letter "O" in "ON".

1. Press .

A rectangular display showing "ALM-" on the left and "12:00R" on the right. Above "12:00R" are a bell icon, a sun icon, and the number "4".

The display shows the current settings for the Date Alarm with the month digit flashing.

2. To select the month, press  or .
3. Press  to move to the next part of the display.
Repeat the process to set the day of the month, hour, minutes and alarm type (audio or vibrate).
4. Press  to enter the Date Alarm settings into memory.
The display returns to Standby.
If you activated an alarm, a bell appears in the display.
(See “Activating the Date Alarm,” page 16.)

Receiving/Displaying Messages

When you first turn the pager on and no messages are stored in memory, you will see the Standby display:



Receiving Normal Messages

With Quick View and Time Stamp Off

1. The pager beeps (or vibrates) for eight seconds, indicating an incoming message, and the "CALL" screen appears.



2. Press any key to stop the alert.



3. To see the message, press .

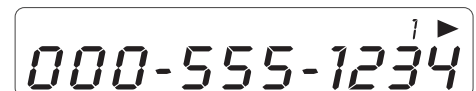

■ To scroll through the messages, press  again.

4. To return to Standby, press  or .



Note: With Time Stamp on - the day/date/time displays before the message.

With Quick View On and Time Stamp Off

1. When the pager receives a message, it beeps (or vibrates) for about eight seconds.

2. The message automatically appears on the LCD display.



You don't need to press any keys.
(See "Activating Quick View," page 8.)

If longer than 12 characters, the second part of the message appears.



The FLX 9050 continuously displays the message, switching screens every two seconds.

Three minutes later, if no keys are pressed, the pager beeps (or vibrates) for eight seconds to remind you of the message.

This repeats every three minutes up to 10 times.

3. Press any key to stop the alert.
The display changes, indicating you have a message in memory.



This display is also called a Standby display.

Note: *If the pager gets another message before you stop the alert, you'll get a new alert, the new message appears, and the previous message is stored in memory. The Unread Message Reminder continues until both messages are viewed. (See "Unread Message Reminder," page 22.)*

Receiving an Urgent Message

If you have the pager set to Audio Alert, the Alert-1 Tone sounds regardless of which audio tone you selected.

Note: *The pager vibrates normally if that alert mode is selected. (See “Alert Tone,” page 4.)*

With Quick View on,
“URGENT” displays first and the message automatically follows.

A rectangular display box with rounded corners showing the word "URGENT" in a stylized, outlined font.

With Quick View off,
press any key to stop the alert.
Press  to view the message.





A rectangular display box with rounded corners. On the left, it shows "ECALL" in a stylized font. On the right, it shows the time "10:45A" with "12/1" above it.

Urgent Message Reminder

If you receive an urgent message and do not read it right away, you will hear a rapid Alert tone every two minutes. This Urgent Message Reminder will continue until canceled.

A rectangular display box with rounded corners. On the left, it shows "MO" above "E0000" in a stylized font. On the right, it shows the time "10:45A" with "12/1" above it.

Canceling Urgent Message Reminder

1. Press  or  to view the urgent message.
2. Press and hold both  and  until you hear a short beep.

A rectangular display box with rounded corners showing the word "URGENT" in a stylized, outlined font.

When **Time Stamp is on**, you can cancel the Urgent Message Reminder from the Time Stamp display.

1. Press  or  to view the urgent message.



2. Hold both  and  until you hear a short beep and the “UR” disappears.



The Urgent Message Reminder is canceled, but “URGENT” remains in the display and the message remains in memory. (To remove the urgent message from memory, see “Deleting Messages,” page 24.)

3. Press  or  to return to Standby.

Tone Only Messages

The FLX 9050 indicates when it has received a “tone only” message (a message without numeric characters). **Example:** Such a message could be an automatic page alerting you to messages on your voice mail.



Unreadable Message

If a message is received that is partially or totally unreadable, the unreadable characters are replaced with “u” (lower case letter “u”).



Unread Message Reminder

With Auto Reset active, if a message is not read immediately, an eight-second Unread Message Alert reminds you every three minutes.



Until you read the message, the alert will repeat 10 times.

With the Non-stop duration mode active, the Alert tone continues until you recognize the page.

Reading Messages

The pager stores and numbers up to 30 messages in memory arranged from newest to oldest. Number 1 is given to the first message received.

To read stored messages, press  to see the most recent message received.



Or, press  to see the first message received.

A typical message can have up to three parts, depending on which pager features are activated.

Press  to see each part in succession.

■ If Time Stamp is on when paged, the date and time screen alternates with the message.



If the Time Stamp and User Message are on, the Time Stamp has a special designation for Urgent Messages:





- If an Urgent Message is received with Time Stamp off and User Message on, “URGENT” displays as the second part of the message. (See “Activating Message Tag,” page 26.)



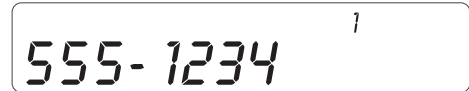

Next is the message proper (telephone number to call, etc.).



If the message is more than 12 characters long, press  to see the rest of the message.

The display automatically returns to Standby after eight seconds. Or, press either  or  to return to Standby.

Note: *If you press  once to view a message, the display automatically scrolls through all elements of the message every eight seconds. To view the next message, press  before the pager display returns to Standby.*

Deleting Messages



Deleting Individual Messages:

1. To see the message, press  or  as appropriate.



2. Press and hold .
The display alternates between “DELETE NO-??” and the message to be deleted.



3. While holding , press  or  to delete the message.



4. The display returns to standby.



Note: *Before deleting an Urgent Message, cancel Urgent Message Reminder. (“Canceling Urgent Message Reminder,” page 20.)*

To Delete All Messages:

1. To reach the Delete All menu,

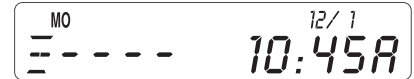

press: display:



USER MENU



2. Press and hold .
The display alternates between
“DELETE ALL” and
“ARE YOU SURE?”

DELETE ALL

ARE YOU SURE?

3. While holding ,
press  or 
to delete all messages.

ALL DELETED

Note: *If you do not want to delete all messages,
release  and (to return to Standby)
press  twice.*

4. The display returns to Standby.

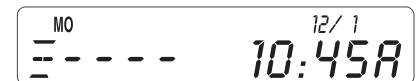

Note: *If an urgent message is in memory, the Delete All feature will not show in the Menu screens until the Urgent Message Reminder is canceled. (See “Canceling Urgent Message Reminder,” page 20.)*

Message Tagging

- Your FLX 9050 comes with word files **00** through **05** preprogrammed.
- -00 URGENT is the first word and can't be changed.
- You can change the 8-character words (01 - 05). See "Storing Words in the Message Files," page 29.

Activating Message Tag

Note: *User Message must be on before the Message Tag can be activated.*

Without messages in memory:

1. To reach the User Message menu,



press:

display:



USER MENU



ALERT SET



AUTO HYPHEN



USER MESSAGE



USER MSG OFF

2. 

USER MSG ON

2. 

USER MSG OFF

3. To enter the selection into memory and return to standby, press .



With messages in memory:

1. To reach the User Message menu,

MO 12/1
0000 10:45A

press:

display:



USER MENU



DELETE ALL



ALERT SET



AUTO HYPHEN



USER MESSAGE



USER MSG OFF

2.

USER MSG ON

2.

USER MSG OFF

3. To enter the selection into memory and return to standby, press .

MO 12/1
0000 10:45A

Viewing the Message Files

Without messages in memory:

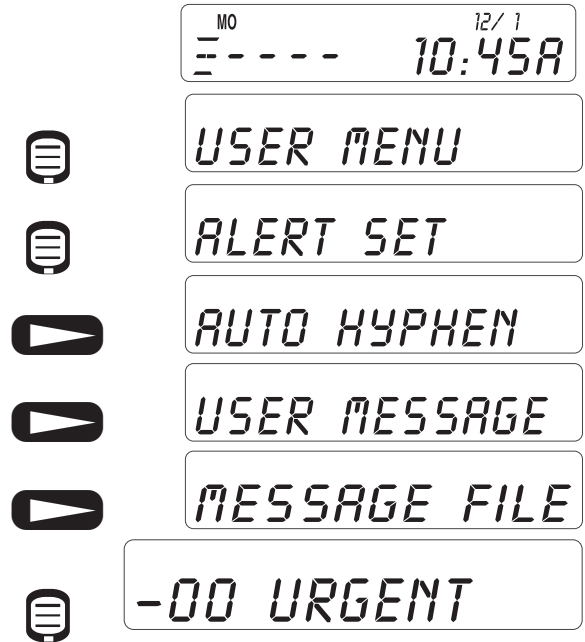

The display shows the first word in the Message File.
To see other Message File words, press  or .

With messages in memory:

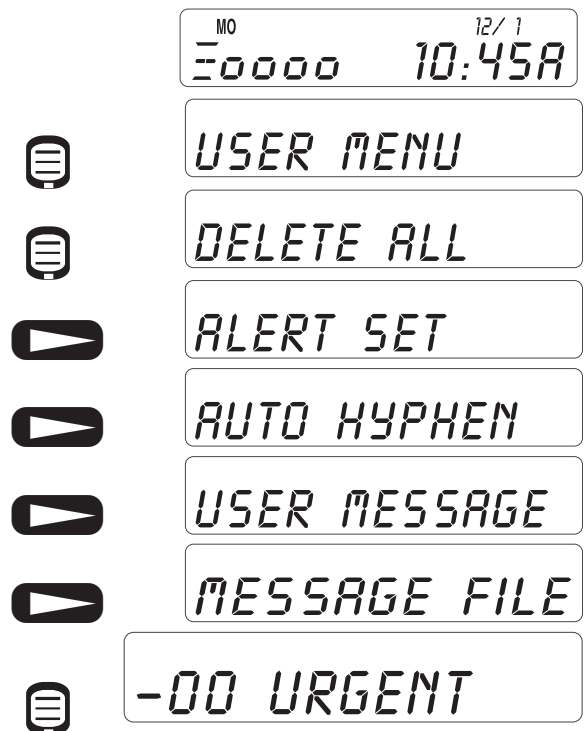

The display shows the first word in the Message File.
To see other Message File words, press  or .

Storing Words in the Message Files





Note: *Message Tag must be on before you can store alphanumeric characters in the files.*



Remember:

- Your FLX 9050 comes with word files **0** through **5** preprogrammed.
- -00 URGENT is the first word file. It **can't** be changed.

Move to the Message File Menu

(See page 28.)

press:	display:
	MESSAGE FILE
	-00 URGENT
	-01 HOME
	-02 OFFICE
	-03 HUSBAND

1. Hold both  and  for about two seconds until the display lights and “A” flashes.



2. Press either  or  to scroll through the characters.

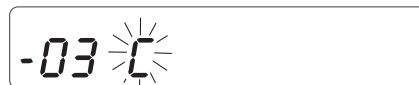

Note: *The alphanumeric characters start with A and go to Z, 0, 1 through 9, -, +, /, \, :, ?, [,], * and cycle back to A.*

3. When you reach the character that you want to enter, press  :
The same character repeats in the next space.

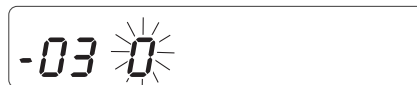

Repeat steps 2 and 3 to select your word or phrase until you select the last character.

4. When you select the last character, press and hold  for about two seconds.
The display lights and the character stops flashing.





5. To store other words or phrases in the other Message files, repeat steps 2 through 4.

6. To end, press  .



Receiving Urgent Messages

With Quick View Off

1. When the pager beeps or vibrates, the “CALL” screen appears. Press  twice to read the urgent message.
2. Press  or  to return to Standby.



With Quick View On and Time Stamp Off

1. The Alert Tone sounds (if any audio alert is selected) or the pager vibrates (if that alert mode is selected).
2. “URGENT” appears on the display first, without touching any other keys. The rest of the message follows automatically, switching screens every two seconds.
3. Press any key to stop the alert.



Receiving an Urgent Message with User Message and Time Stamp On and Quick View Off:

1. The pager sounds the Alert Tone (or vibrates), and “CALL” appears in the display.



2. Press any key to stop the alert.

Press  to read the message.

Press  to return to Standby.



Receiving an Urgent Message with Quick View, User Message, and Time Stamp On:

■ With User Message off, an urgent call is interpreted as a normal page.

■ To receive an Urgent Message, User Message must be on.

1. The pager sounds the Alert Tone (or vibrates).

2. The message appears on the display. The display scrolls automatically through all elements of the message, switching screens every two seconds.

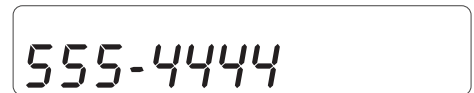

3. Press any key to stop the alert. The display returns to Standby.



Replacing the Battery

Low Battery Alarm

When the battery is low, the FLX 9050 gives a visual alert and emits a four-second, low-beep tone once every 30 minutes.



BATTERY LOW

Installing the Battery

1. Slide off the battery cover.

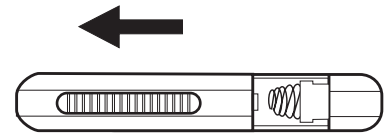

2. Insert a AAA battery.

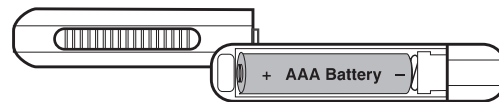

Note: *When inserting the battery, be sure the + and - terminals are facing the proper direction.*

3. Slide the battery cover on.

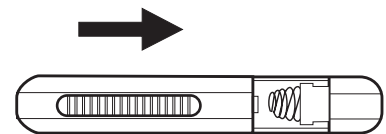

Memory Saver

A built-in memory saver allows two minutes to change the battery without losing messages, time or calendar settings, and user-selected feature settings.

When the pager is turned off, the AAA battery keeps the memory active.

Belt Clip

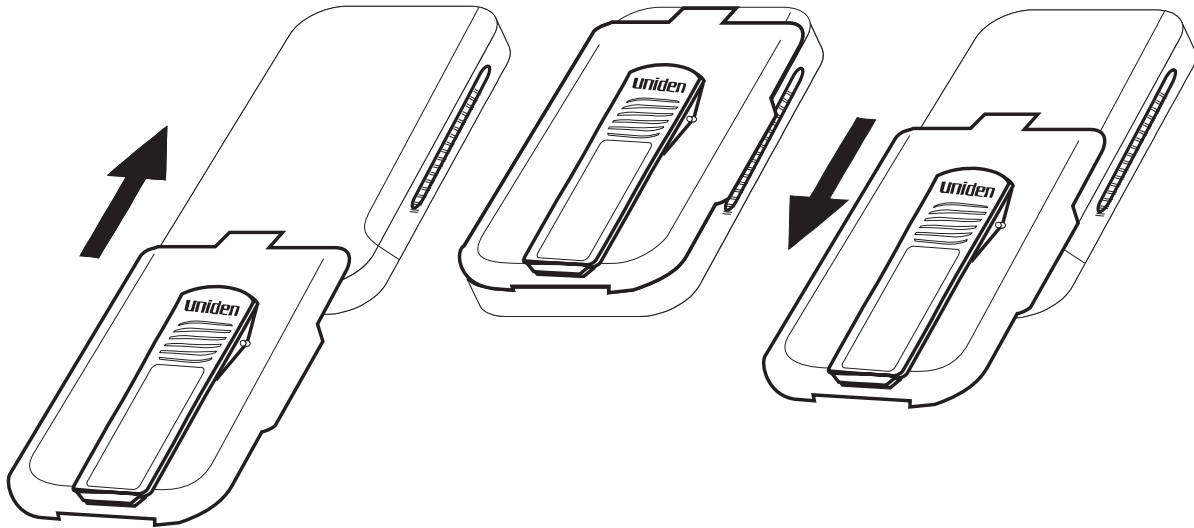

- Slide the pager in the holster until it clicks into place.
- Use the spring clip to attach the pager-holster combination to your belt or pocket for convenient portability.
- When the pager receives a message, you can easily slide it out of the holster to view messages.

Care and Maintenance

- Keep pager dry. If it gets wet, wipe dry immediately.
- Use and store only in normal temperature environments.
- Keep the pager away from dust and dirt.
- To clean the pager, wipe occasionally with a damp cloth. Do not use harsh chemicals.

FCC Notice

This device complies with Part 15 of the FCC Rules.
Operation is subject to the following two conditions:

This device does not cause harmful interference.

This device must accept any interference received,
including any interference that may cause undesired
operation.

uniden®

FLX 9050 Pager

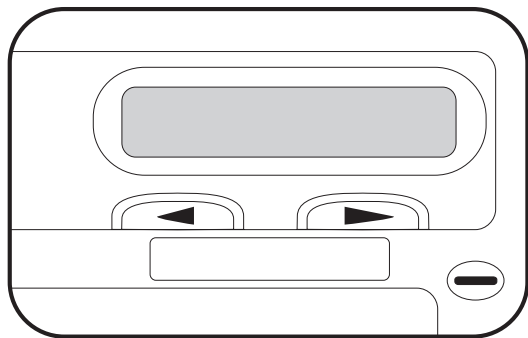

Operating Guide

Contents

Controls	1
Display Indicators	2
Introduction	3
Pager Setup	4
Setting Time & Date Functions	10
Activating and Setting Alarms	13
Receiving/Displaying Messages	18
Deleting Messages	24
Message Tagging	26
Replacing the Battery	33
Belt Clip	34
Care and Maintenance	34
FCC Notice	35
Visual Guide	inside front cover

U.S. patent: 5,398,022

FLX 9050 Pager Visual Guide Part 1

(No messages in memory)

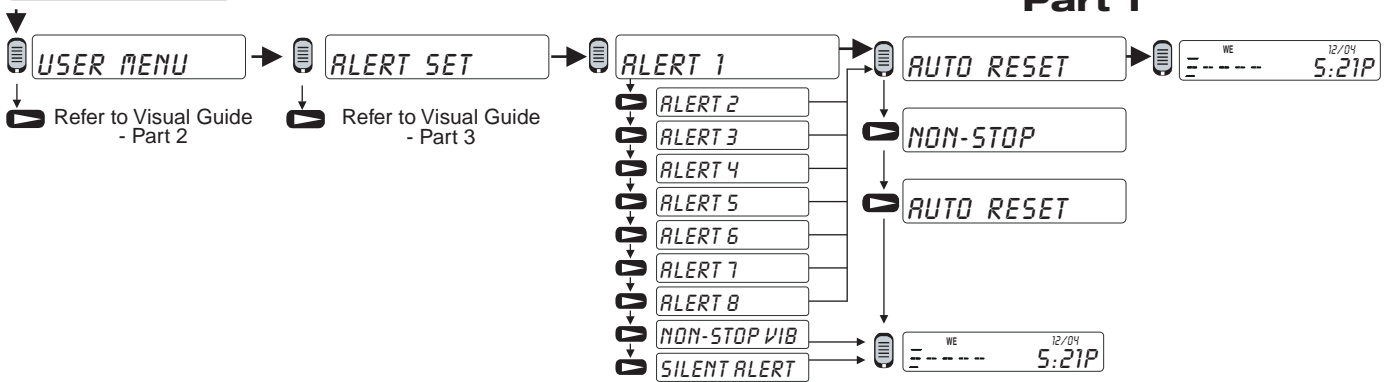

(With message in memory and Quick View off)

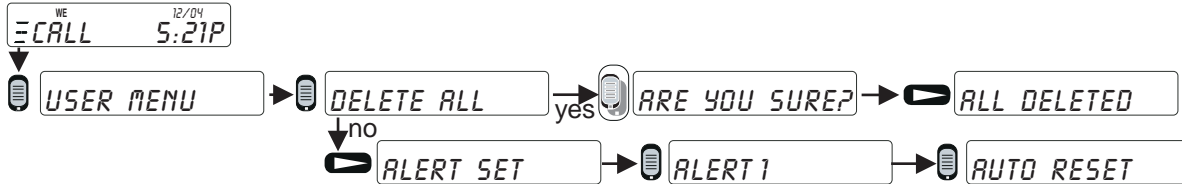

- Press and release Side key
 Press and hold Side key
 Press and release key
 Press and hold key
 or Press and release Backward key or Forward key
 + Press and hold Backward key and Forward key at the same time

Key Guide

FLX 9050 Pager Visual Guide

Part 2

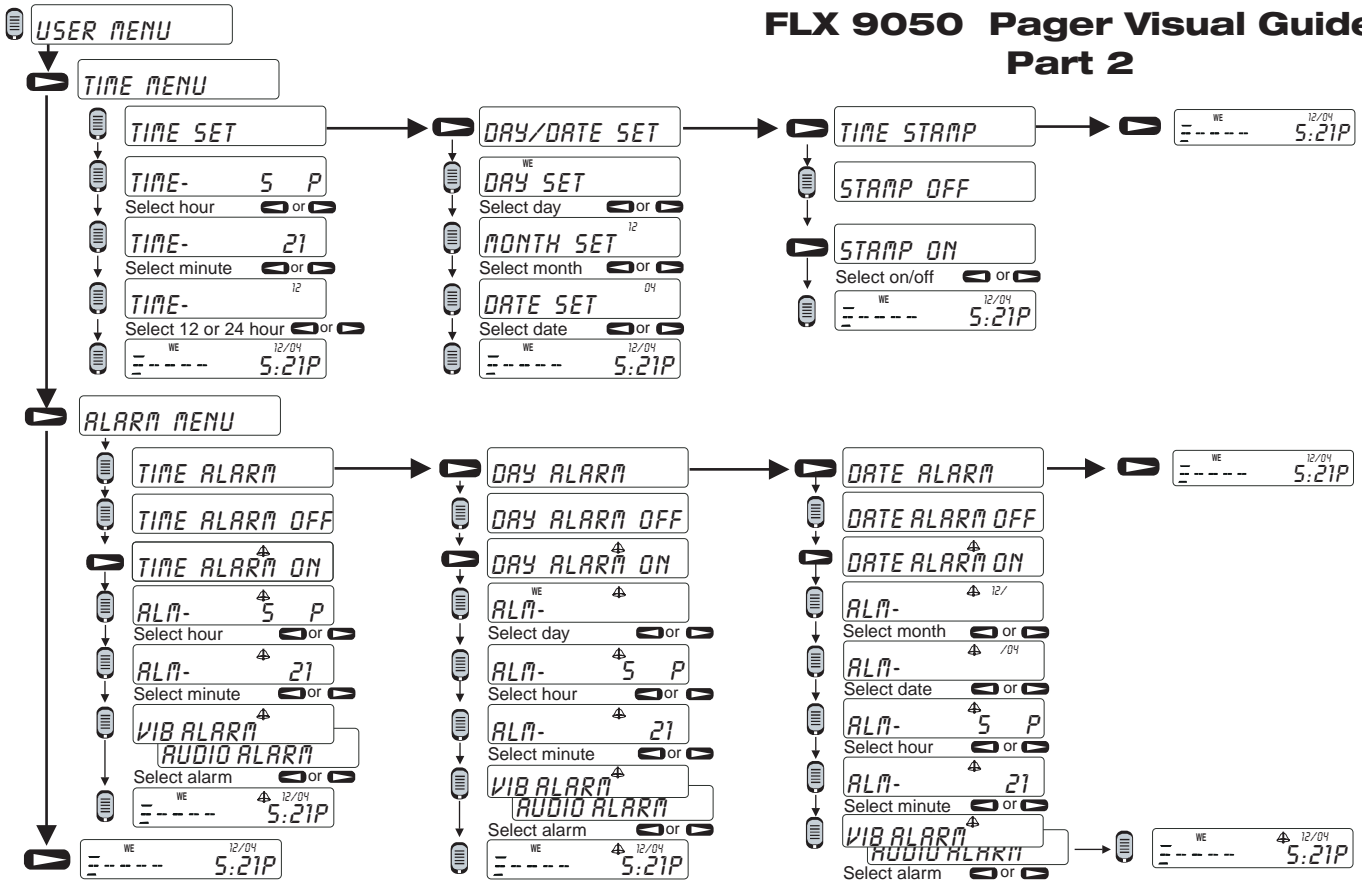

FLX 9050 Pager Visual Guide Part 3

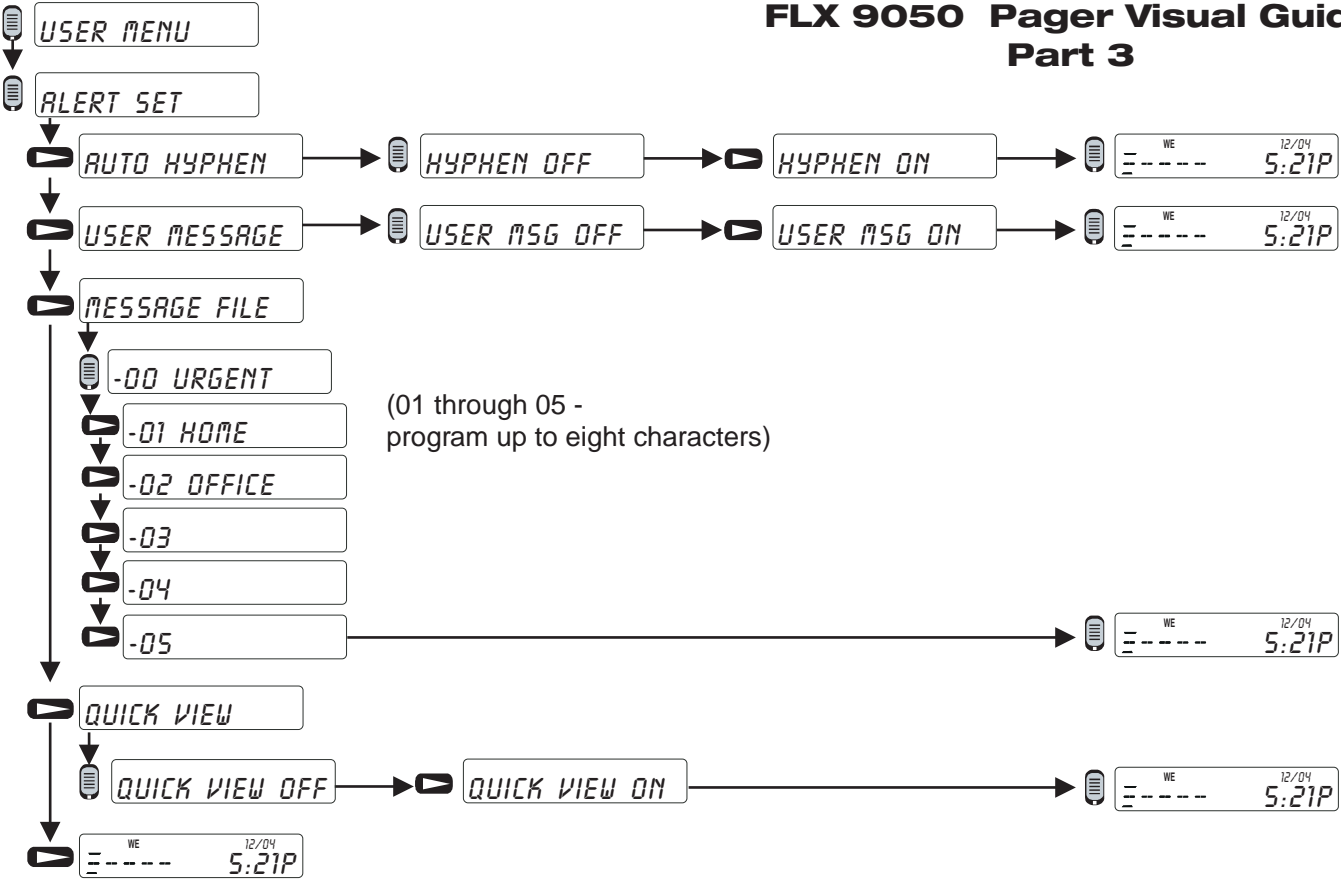

U.S. patent: 5,398,022

uniden®